

---

## ІНФОРМАЦІЙНО-КОМУНІКАЦІЙНІ ТЕХНОЛОГІЇ ТА МАТЕМАТИЧНЕ МОДЕЛЮВАННЯ

---

UDC 004.7:[519.876.5:656.212.5]

V. M. PAKHOMOVA<sup>1\*</sup>, D. I. NAZAROVA<sup>2\*</sup>

<sup>1\*</sup>Dep. «Electronic Computing Machines», Dnipro National University of Railway Transport named after Academician V. Lazaryan, Lazaryana St., 2, Dnipro, Ukraine, 49010, tel. +38 (056) 373 15 89, e-mail viknikpakh@gmail.com, ORCID 0000-0002-0022-099X

<sup>2\*</sup>Dep. «Electronic Computing Machines», Dnipro National University of Railway Transport named after Academician V. Lazaryan, Lazaryana St., 2, Dnipro, Ukraine, 49010, tel. +38 (056) 373 15 89, e-mail olkdi@outlook.com, ORCID 0000-0002-7134-9416

### ORGANIZING WIRELESS NETWORK AT MARSHALLING YARDS USING THE BEE METHOD

**Purpose.** In general, today wireless networks are widely used as an alternative to wired, allowing you to connect multiple devices, both among themselves in the local and global Internet. However, at the present stage in Ukraine there is no widespread use of a wireless network at rail transport, therefore it is advisable to conduct research on the deployment of such a network, in particular, at a marshalling yard. **Methodology.** Using LocBS-BeeCol program model written in Python according to the bee colony algorithm the optimal number of base stations (BS) of the wireless network and their location at the marshalling yards was determined, as well as research on the bee algorithm parameters was conducted. Input data of the LocBS-BeeCol model are as follows: marshalling yard parameters (area, number of clients that need to be connected to base stations); wireless network parameters (base station coverage radius, maximum number of clients for one base station); parameters of the bee colony algorithm (number of scout bees, number of attempts to find the optimal solution using one bee). **Findings.** For marshalling yards of various capacities (small, medium and high), the optimal number of base stations of the wireless network was obtained with restrictions on the coverage radius of the base station and the number of clients connected to it. Thus, for example, to connect 300 clients at medium-sized marshalling yards with an area of 2500x500 m<sup>2</sup>, 93 base stations with a coverage radius of 50 m are needed. **Originality.** The quality of the obtained solutions significantly depends on the choice of the bee colony algorithm parameters. A study of the base stations number of the wireless network and search time for finding the optimal solution for different number of bees and the number of attempts to find the optimal solution using the bee for marshalling yards of various capacities was carried out. It was determined that an increase in the number of bees (from 10 to 50) and the number of attempts to find the optimal solution by a bee (from 10 to 50) improves the quality of the optimal solution (decrease in the number of base stations by an average of 6.5% and 9.3%), respectively. In addition, increase in the bee number (from 10 to 50) reduces the search time for the optimal solution by bees by an average of 1.8 times, while increase in the number of attempts to find the optimal solution by a bee (from 10 to 50) will increase search time for the optimal solution on average 2.14 times. **Practical value.** An algorithm and its software implementation have been developed, which make it possible to determine the required number of base stations and their location when deploying a wireless network at a marshalling yards. For marshalling yards with high capacity, when the coverage radius of the base station is doubled (from 50 to 100 m), their number decreases by about half (from 136 to 64), while the time for finding the optimal solution by bees increases by 2.5 times (from 8.4 to 20.6 s).

*Keywords:* marshalling yard; wireless network; base station (BS); coverage radius; bee method; bees; attempts; search time

## Introduction

A wireless network is a connection of computers and other devices for information exchange without the use of wires; the connection is made through radio channels. The installation of a wireless network is necessary when the deployment of a cable system is impossible or economically impractical. Wireless networks have significant advantages over wired ones [5, 11–12]: they allow deploying the network in places where wires cannot be used and maintain a sufficient data transfer rate. Wireless networks also provide easy connection, user mobility, quick troubleshooting, and network equipment availability.

According to their size, the wireless networks are divided into (Fig. 1) [5, 11–12]: Wireless Personal Area Networks (WPAN) – up to 10 m; Wireless Local Area Networks (WLAN) – up to 100 m; Wireless Metropolitan Area Networks (WMAN) – up to 50 km; Wireless Wide Area Network (WWAN).

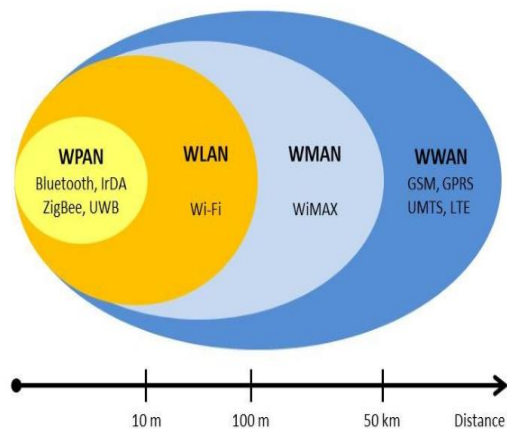

Fig. 1. Classification of wireless networks

According to the topology, wireless local area networks are divided into ad-hoc temporary networks (Independent Basic Service Set, IBSS); Basic Service Set (BSS); Extended Service Set (ESS). It is known that there are two main methodologies for WLAN deployment: wireless LAN with maximum service area; wireless LAN with maximum capacity [5, 11–12].

Scientists such as Ye. S. Skakov, V. M. Malyshev, dealt with the planning of wireless networks [1]. To solve this problem, it is possible

to use intelligent methods of multiagent optimization, which include bee, ant, particle swarm, bat, fireflies and other algorithms [1, 2, 18]. The work [1] determines that the bee method is the most suitable for solving the problem of locating base stations of a wireless network.

The bee method has some modifications [7–8], one of which is BCOi (Bee Colony Optimization based on the improvement concept). Its peculiarity is that the work with complete solutions of the optimization problem is considered, not with partial ones, as in the classical BCO method [1].

Since 2008, the GSM-R (Global System for Mobile Communications – Railway) standard has been used in European railways to ensure secure wireless communication between railway services and trains [3, 6, 7, 16]. The GSM-R network is used to provide the European Train Control System (ETCS) [16]. In the UK, the GSM-R network has been fully operational since 2015 [16]. Today in Europe we are talking about transition to more modern technologies such as 4G/LTE and 5G [19]. In the future, the following new services are expected at railway transport: on-board and roadside HD video surveillance, multimedia dispatcher video streams, sensor information from railway infrastructure, including bridges, viaducts, tunnels, track defects, etc. Using infrared, sound and temperature sensors, information is collected and sent to a computation center [4].

At the present stage in Ukraine, research is being conducted on the information and telecommunication system (ITS) of railway transport using artificial intelligence methods [13–15, 20]: neural and fuzzy networks, ant and genetic methods. But the results of the introduction of wireless networks at railway transport are not sufficiently presented yet. The authors considered the possibility of using WLAN technology for the implementation of mobile communication at railway stations, made a base station state chart in the Distributed Coordination Function (DCF), which is mandatory and based on the protocol, providing Carrier Sense Multiple Access with Collision Avoidance (CSMA/CA). Now it is expedient to conduct a study of the optimal number of base stations of the wireless network, in particular at the marshalling yard, which reaches the lower level (line enterprises) of the ITS of the railway transport of Ukraine.

## ІНФОРМАЦІЙНО-КОМУНІКАЦІЙНІ ТЕХНОЛОГІЇ ТА МАТЕМАТИЧНЕ МОДЕЛЮВАННЯ

**Purpose**

In our work, we plan to investigate the deployment of a wireless network and search for the optimal number of base stations according to the bee colony algorithm for marshalling yards of different capacities. Python language was chosen for software implementation.

**Methodology**

*Problem statement.* The marshalling yard (Fig. 2) includes arrival park, sorting park, hump and departure park. The most important part of the

technological process is the hump, the capacity of which (small, medium, high and increased) depends on the number of sorting sets (2, 3, 4, 6-8, respectively). At the object under study there are various technological areas (point section, speed measuring and cut acceleration in the section of 1–2 BP (brake position) and 3–4 BP, measuring cut parameters, uncoupling control, cut mass determination) with various ground equipment: track sensors and photodetectors; track circuits; weight measuring devices; radar velocity meters and others.

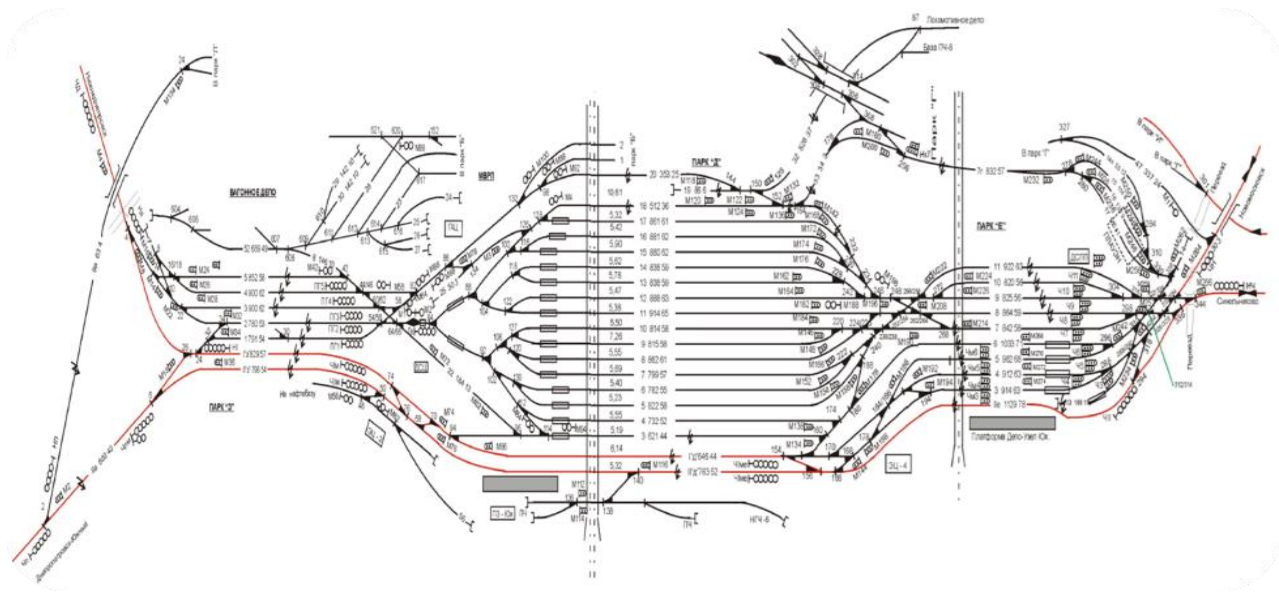

Fig. 2. Scheme of marshalling yard

Let  $L$  be the total number of clients to be connected to the wireless base station at the marshalling yard. Known  $M$  – are the candidate places where WLAN base stations can be installed. In addition, all clients must be connected to base stations.

Let us introduce the notation  $BS_i(r)^k$  – the  $i$ -th base station of the wireless network with a coverage radius  $r$ , to which  $k$  clients are connected, where  $i \in [1; M]$ ;  $k \in [1; L]$ . If  $BS_i(r)^k = 1$ , then  $i$ -th base station with  $k$ -clients is connected to the WLAN, in other case  $BS_i(r)^k = 0$ .

Let us consider the following function as a target one:

$$F = \sum_{i=1}^M BS_i(r)^k \rightarrow \min, \quad (1)$$

moreover, it is necessary to comply with the restrictions:

$$r \leq r_{\max}, \quad k \leq k_{\max}, \quad (2)$$

Where  $r_{\max}$  – is maximum coverage radius of the base station WLAN;  $k_{\max}$  – the maximum number of clients that are connected to the WLAN base station.

*Wireless network deployment at the marshalling yard.* Given the characteristics of the marshalling yard, in the future we are talking about WLAN planning.

## ІНФОРМАЦІЙНО-КОМУНІКАЦІЙНІ ТЕХНОЛОГІЇ ТА МАТЕМАТИЧНЕ МОДЕЛЮВАННЯ

According to the IBSS topology (Fig. 3) [5, 11–12], client stations interact directly with each other without an access point. Ad Hoc mode requires minimum of equipment – a wireless adapter. This configuration does not require the creation of any network infrastructure. In this mode, each node participates in routing by sending data to other nodes, so determining which nodes send data is done dynamically based on the network connection and the routing algorithm used. Ad-Hoc mode is used mainly to create temporary networks.

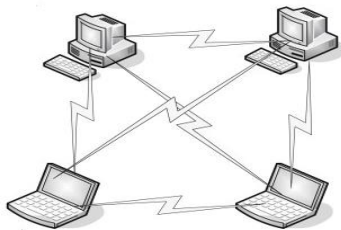

Fig. 3. IBSS topology

According to the BSS topology (Fig. 4) [5, 11–12], network nodes interact with each other not directly, but through an access point (AP), which can play the role of a bridge for connection to external cable network. All base stations in the network are interconnected by Distribution System (DS), which can be radio or infrared waves.

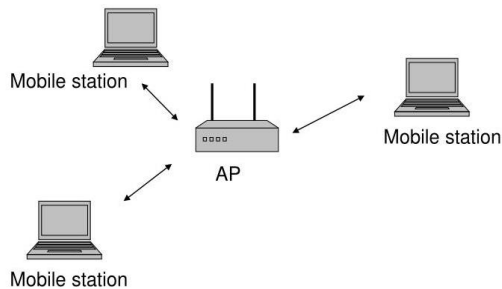

Fig. 4. BSS topology

The ESS topology (Fig. 5) [5, 11–12] makes it possible to combine several access points, i.e. connects several BSS networks. In this case, the access points can interact with each other. This topology is useful when you need to connect multiple users to a single network or connect multiple wired or wireless networks.

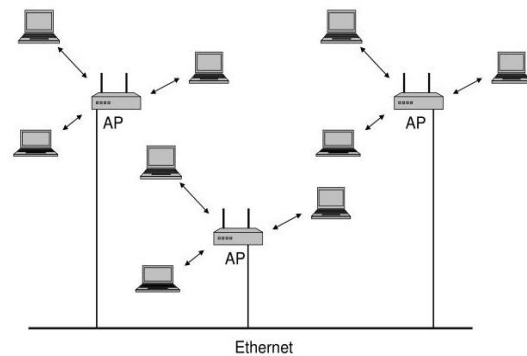

Fig. 5. ESS topology

It is advisable to use the ESS topology at the marshalling yard, as you can use several access points that interact with each other. In addition, there are wired networks at the marshalling yard, with which it is necessary to exchange information.

WLAN focused on the service area are developed taking into account the provision of maximum coverage with the minimum possible number of access points, Fig. 6. [5, 11–12].

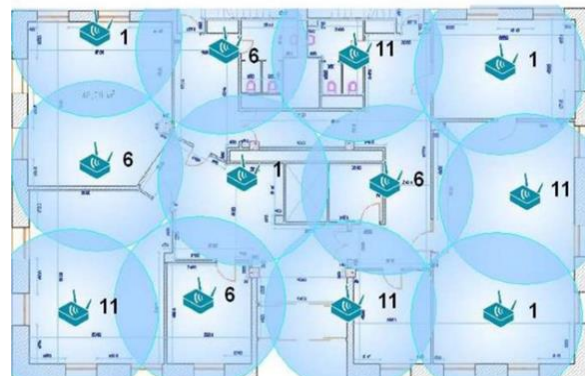

Fig. 6. Service area oriented WLAN

In a typical service area oriented network, the ratio of the number of users to the number of access points is 25:1. Some typical features of WLAN are focused on the maximum service area: the use of bursty applications with low packet rate, for example, those generating requests to databases; the need for low spectral bandwidth requirements, so that the data flow rate can be reduced to a minimum of 1 and 2 Mbps; ensuring easy maintenance, as WLAN maintenance staff is small. In service area oriented networks, typical programs have low packet rate and low spectral bandwidth requirements. This approach allows many users to immediately access WLAN services

## ІНФОРМАЦІЙНО-КОМУНІКАЦІЙНІ ТЕХНОЛОГІЇ ТА МАТЕМАТИЧНЕ МОДЕЛЮВАННЯ

while maintaining sufficient characteristics of the latter. Such options are common for small or medium-sized affiliates, when WLAN is chosen as an alternative to wired Ethernet. Easy-to-deploy WLAN provide basic LAN connections that are not required for file and printer sharing. Each WLAN access point serves approximately 25–30 users [5, 11–12].

Wireless LAN that focus on high bandwidth (Fig. 7) should provide maximum performance and packet rate for each BSS client.

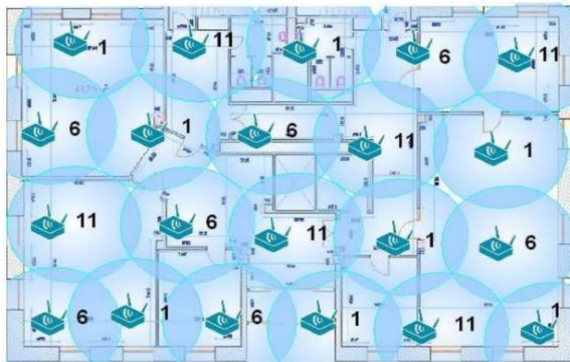

Fig. 7. WLAN focused on maximum spectral bandwidth

The cell size of the bandwidth-oriented WLAN is smaller than that of the WLAN, which focuses on the maximum service area, respectively, the location density of access points is higher. High-bandwidth-oriented WLAN are required when one uses applications that require high packet rates; uses applications that are sensitive to delays; deploys subnets of smaller scales (or several subnets in one service area); there is a high density of user placement. In such networks, the number of access points is several times greater than that for WLAN oriented on service area. The service area of each access point is much smaller than when building a network focused on the maximum service area. Each access point serves about 12 users [5, 11–12].

For a marshalling yard, it is advisable to use WLAN deployment methodologies that focus on maximum bandwidth, wireless LAN should provide maximum performance and packet rate for each client.

*Choice of organization algorithm of wireless network at marshalling yard.* Nowadays, there are many different swarm algorithms, which can be divided into [2, 18]: swarm algorithms based on the behavior of insects and animals; swarm algo-

gorithms based on bacterial behavior and inanimate nature. The first include the following algorithms: particle swarm algorithm; ant algorithm; bee algorithm; fireflies algorithms; cuckoo search algorithm; bat algorithm. The second include gravitational search algorithm; intelligent drip algorithm; stochastic diffusion search; bacterial optimization.

Particle swarm algorithm is proposed to optimize continuous nonlinear functions. Ant algorithm is one of the most efficient polynomial algorithms for finding approximate solutions to route search problems on graphs. Bee algorithm is a relatively new algorithm for finding global extremums of complex multidimensional functions. According to the bee algorithm, bees explore areas that are near elite ones, which allows you to approximate the solution to optimal. The advantage of the algorithm is the possibility of efficient division into parallel processes and high speed [2].

*Biological bases of the bee method.* Bees in nature search for food by studying the space around their hive (Fig. 8) [17].

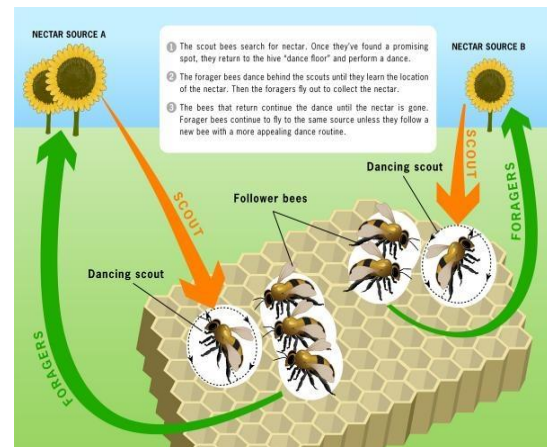

Fig. 8. Nature analogue

Review of the sources [1–2, 8–10] showed that, as a rule, at the initial stage, several scout bees study the environment. After the search, scout bees return to the hive and inform the other members of the swarm about the location, quantity and quality of available food sources that they have found. The information exchange takes place with the help of dance on a specially designated area. If a bee watching a skate dance decides to leave the hive and collect nectar, it will follow one of the scouts to one of the previously found food sources. Such a bee becomes a busy forager. It collects nectar,

## ІНФОРМАЦІЙНО-КОМУНІКАЦІЙНІ ТЕХНОЛОГІЇ ТА МАТЕМАТИЧНЕ МОДЕЛЮВАННЯ

while clarifying information about the amount of nectar near the source found. After collection, the forager returns to the hive and leaves the nectar there. It can then do one of the following: become a free forager, leaving its current source of nectar; continue extracting nectar from its source without recruiting free bees by dancing; continue extracting nectar from its source, while recruiting free bees.

Described process continues unabated, while the hive accumulates nectar and explores new areas with potential food sources.

*Bee colony algorithm*, the enlarged scheme of which is presented in Fig. 9 [10]. First the colony is initialized, then the solution is searched, after which the bees exchange information in the hive with the help of dance, then the colony is initialized again until the stopping criterion is found, after which the optimal solution is found.

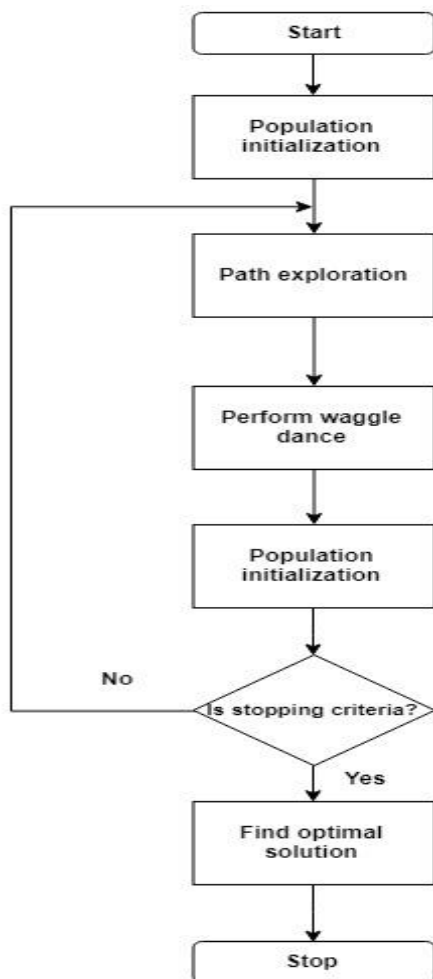

Fig. 9. Block diagram of the bee colony algorithm

*Software implementation of the bee colony algorithm* is performed in Python using standard libraries: Os – is responsible for interaction with the OS; Sys – is responsible for system functions; Random – is responsible for generating random numbers; Math – is responsible for mathematical operations; Datetime – is responsible for time conversion; Matplotlib – is responsible for plotting.

The structure of the LocBS-BeeCol software model includes the following user classes (Fig. 10): Log – used to debug the program and display the results, it is the parent for all classes; Field is a class for presenting a marshalling yard, where the search for base station location is performed; Hive is a hive class where bee-scouts exchange information and choose the optimal solution, the parent class is Field; Bee is a class of scout bees looking for coordinates of base stations, the parent class is Hive.

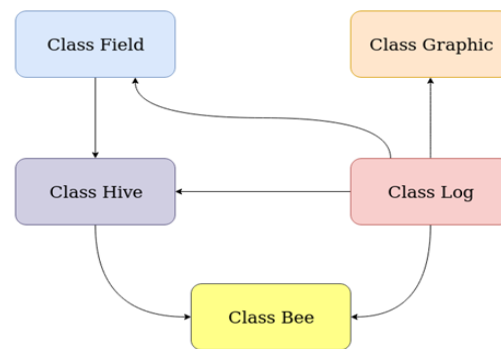

Fig. 10. Interaction of the main classes of LocBS-BeeCol

The location of base stations (BS) at the marshalling yard is based on the algorithm, which is the basis of the LocBS-BeeCol software model and the scheme of which is shown in Fig. 11. First, all classes are initialized. This is followed by a cycle with the premise: whether all customers are covered by base stations. If not, then it is performed the clearing of extremum values, detection of search area coordinates for each bee, then the search for clients in a certain area and the coordinates of the base station are determined, at the end of the cycle the found clients are deleted from the list of free clients. If all clients are covered by base stations, the result will be displayed as a dictionary, the volume of which is the number of BS (res[bs\_count]), and consists of structures whose fields are the location of the BS (new\_bs\_location),

## ІНФОРМАЦІЙНО-КОМУНІКАЦІЙНІ ТЕХНОЛОГІЇ ТА МАТЕМАТИЧНЕ МОДЕЛЮВАННЯ

the number of clients (`clients_in_area`) covered by this BS, and numbers of these clients with coordinates (`clients_in_area_list`) in the form of dictionaries.

Fig. 12 shows a corresponding fragment of the program. In the For cycle (line 28) the required number of bees is created, according to the initial conditions. After creating everything necessary for the work of program, the implementation of the algorithm itself begins. Line 30 starts the While cycle until all clients are connected to the base stations. Inside, the For cycle (line 32) takes place, in

which the extremums and positions for each of the bees are reset to zero (lines 33–35). After specifying the search field (line 36), each bee makes a given number of attempts to find the optimal solution for the location of the base station (line 37). As a result of the cycle iteration, the global extremum, where it is more expedient to install the base station can be found, in this case it will be installed (line 40). Next, the client numbers that are connected to the BS (lines 41–42) are deleted from the general list, and the cycle returns to the beginning.

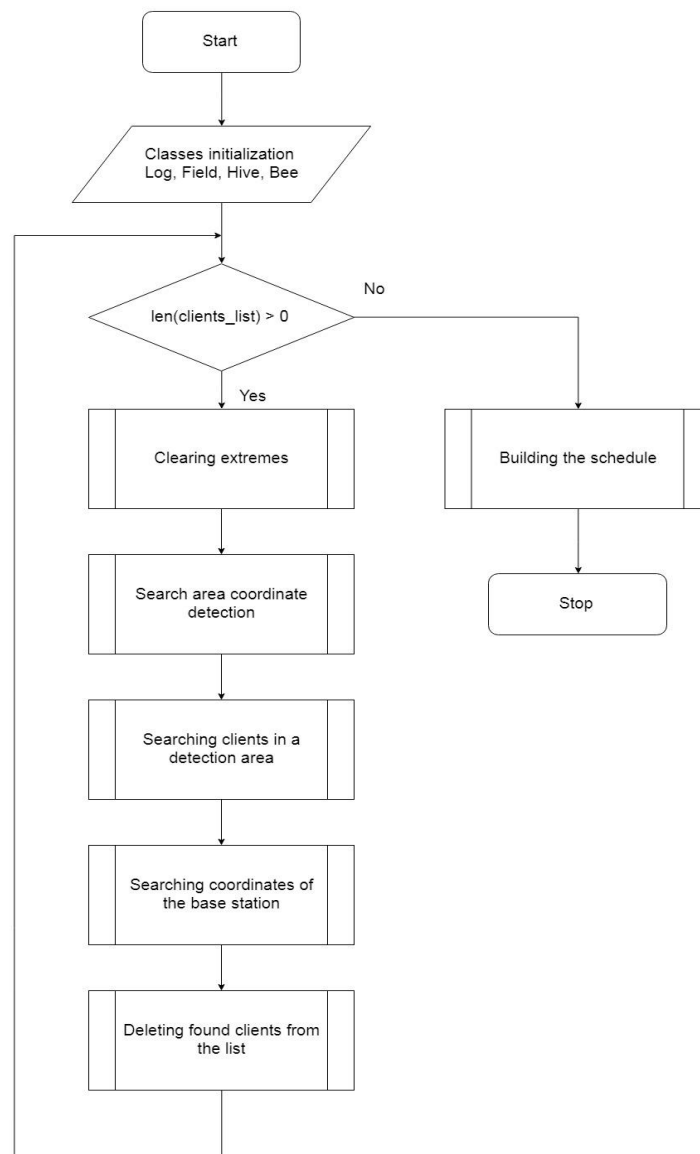

Fig. 11. LocBS-BeeCol model algorithm scheme

## ІНФОРМАЦІЙНО-КОМУНІКАЦІЙНІ ТЕХНОЛОГІЇ ТА МАТЕМАТИЧНЕ МОДЕЛЮВАННЯ

```

28 bees = [bee(hive, log) for i in range(bees_count)]
29 iter_count = 0
30 while len(hive.clients_list) > 0:
31     log.stat("run".upper(), "### Iteration #" + str(iter_count) + " started. ##
    #")
32     for bee in bees:
33         bee.local_extremum = {}
34         bee.location = []
35         hive.global_extremum = {}
36         scouting_area = hive.set_scouting_area(field, bs_area_radius)
37         for _ in range(max_retries_count):
38             for bee in bees:
39                 bee.scout(scouting_area)
40                 bee.set_bs_location(hive.global_extremum)
41                 for key, value in hive.global_extremum["clients_in_area_list"].items():
42                     hive.modify_clients_list({key: value})
43                 iter_count += 1

```

Fig. 12. LocBS–BeeCol program model fragment

## Findings

*Determining the number of BS at the marshalling yard of small capacity.* Input parameters: number of bees (bees\_count) = 10; maximum number of attempts to find the optimal solution (max\_retries\_count) = 10; number of clients (clients\_count) = 250; maximum number of clients covered by one WLAN base station (bs\_max\_clients\_count) = 12; coverage radius (bs\_area\_radius) = 50; field width (field\_width) = 2,000; field height (field\_height) = 400. The results of the model work are shown in Fig. 13.

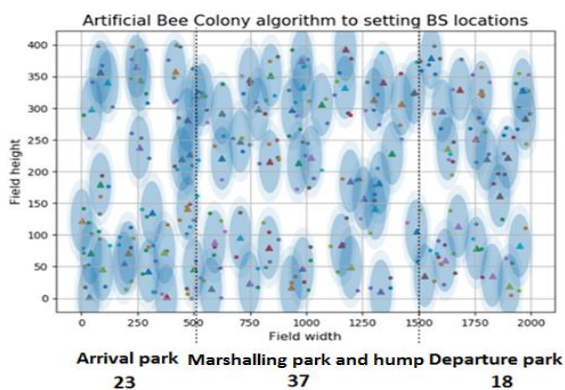

Fig. 13. BS location at the marshalling yard of small capacity

Thus, the recommended number of BS for a small-capacity marshalling yard is 78, 23 of which are in the arrival park, 37 – in the sorting park and the hump, 18 – in the departure park.

*Determining the number of BS at the marshalling yard of medium capacity.* Input parameters: number of bees (bees\_count) = 10; maximum number of attempts to find the optimal solution (max\_retries\_count) = 10; number of clients (clients\_count) = 300; maximum number of clients covered by one WLAN base station (bs\_max\_clients\_count) = 12; coverage radius (bs\_area\_radius) = 50; field width (field\_width) = 2 500; field height (field\_height) = 500. The results of the model work are shown in Fig. 14.

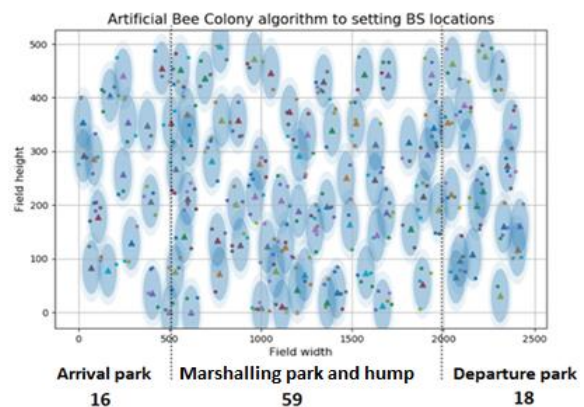

Fig. 14. BS location at the marshalling yard of medium capacity

Recommended number of BS for a medium-capacity marshalling yard is 93, 19 of which are in the arrival park, 59 – in the sorting park and the hump, 18 – in the departure park.



## ІНФОРМАЦІЙНО-КОМУНІКАЦІЙНІ ТЕХНОЛОГІЇ ТА МАТЕМАТИЧНЕ МОДЕЛЮВАННЯ

*Determining the number of BS at the marshalling yard of high capacity.* Input parameters: number of bees (bees\_count) = 10; maximum number of attempts to find the optimal solution (max\_retries\_count) = 10; number of clients (clients\_count) = 350; maximum number of clients covered by one WLAN base station (bs\_max\_clients\_count) = 12; coverage radius (bs\_area\_radius) = 50; field width (field\_width) = 3 000; field height (field\_height) = 600. The results of the model work are shown in Fig. 15.

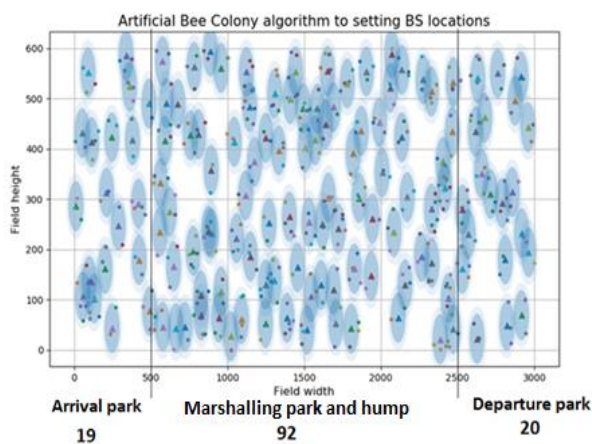

Fig. 15. BS location at the marshalling yard of high capacity

Recommended number of BS for a high-capacity marshalling yard is 131, 19 of which are in the arrival park, 92 – in the sorting park and the hump, 20 – in the departure park.

### Originality and practical value

*Investigation of algorithm parameters.* The quality of the obtained solutions largely depends on the choice of algorithm parameters. Therefore, a study was conducted to identify the dependences of the optimization results (the number of BS of wire network) and the time to find the optimal solution for different numbers of bees and attempts for marshalling yards (MS) of different capacity. The results are presented in Fig. 16–19.

Fig. 16–17 show that increase in the number of bees (from 10 to 50) and the number of attempts to find the optimal solution by one bee (from 10 to 50) leads to a decrease in the number of WLAN base stations by an average of 6.5 and 9.3% respectively.

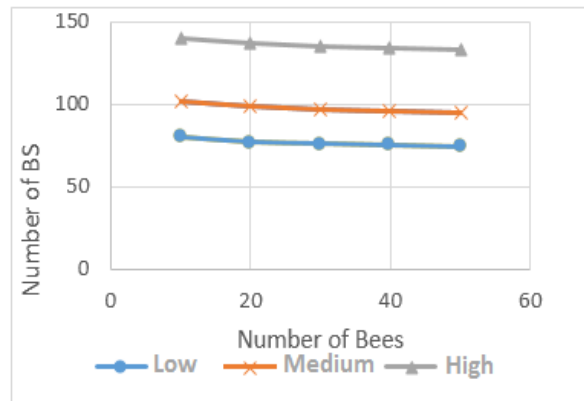

Fig. 16. Optimization results dependence (number of BS) on the number of bees for MS of different capacity

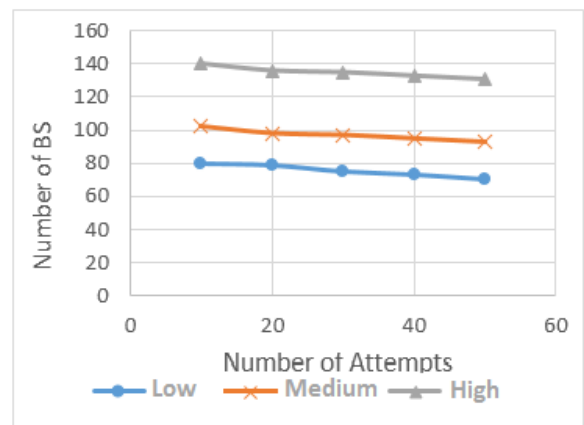

Fig. 17. Optimization results dependence (number of BS) on the number of attempts for MS of different capacity

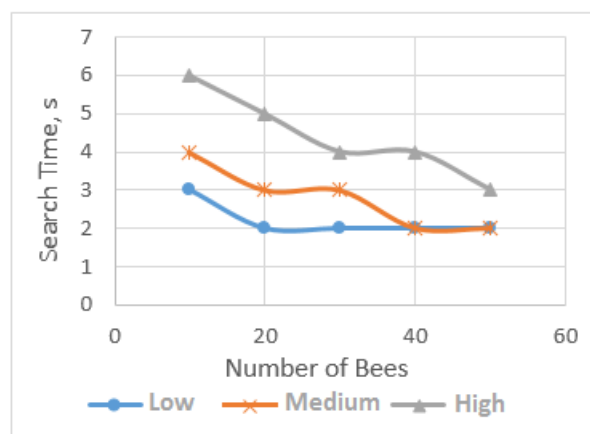

Fig. 18. Dependence of the optimal solution search time on the number of bees for MS of various capacity

## ІНФОРМАЦІЙНО-КОМУНІКАЦІЙНІ ТЕХНОЛОГІЇ ТА МАТЕМАТИЧНЕ МОДЕЛЮВАННЯ

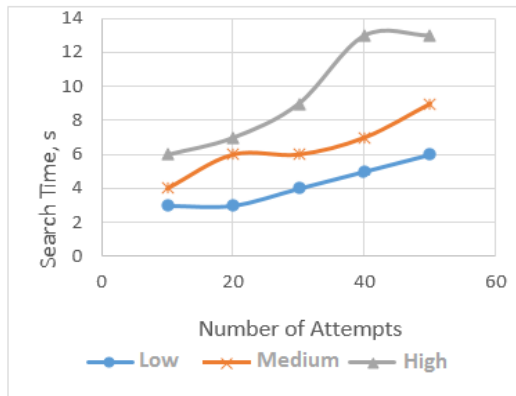

Fig. 19. Dependence of the optimal solution search time on the number of bees for MS of various capacity

Increasing the number of bees (from 10 to 50) reduces the search time for the optimal solution by bees by an average of 1.8 times (Fig. 18), while increasing the number of attempts to find the optimal solution for one bee (from 10 to 50) leads to an increase in the time to find the optimal solution by an average of 2.14 times (Fig. 19).

*Investigation of the coverage radius of the WLAN base station* was performed for a high-capacity marshalling yard. The obtained results on the LocBS-BeeCol software model are summarized in Tab. 1.

Table 1

**The investigation results for high-capacity marshalling yard**

No. of investigation	BS coverage radius, m	BS number	Solution search time, sec
1	50	135	22
2		135	20
3		133	19
4		140	22
5		138	20
	<b>Average:</b>	<b>136.2</b>	<b>20.6</b>
1	100	67	8
2		61	7
3		62	9
4		63	9
5		66	9
	<b>Average:</b>	<b>63.8</b>	<b>8.4</b>

The Table shows that twofold increase in the base station coverage radius (from 50 to 100 m) leads to a decrease in the number of BS approximately twice (from 136 to 64), while the search time for the solution of bees increases 2.5 times (from 8.4 to 20.6 sec). The study was conducted with the following parameters: the number of bees (bees\_count) = 10; maximum number of attempts to find the optimal solution (max\_retries\_count) = 10; number of clients (clients\_count) = 350; maximum number of clients covered by one base station (bs\_max\_clients\_count) = 12; field width (field\_width) = 3,000; field height (field\_height) = 600.

### Conclusions

1. Taking into account the topology of the marshalling yard and the peculiarities of the relevant technological process, it is advisable to use a wireless local area network of the ESS topology with WLAN deployment methodology, focused on maximum bandwidth.

2. Based on the results of the review of scientific sources to determine the optimal number of WLAN base stations and their location at the marshalling yard, the bee method was used, the advantages of which include the possibility of effective division into parallel processes; high speed work.

3. Based on the bee colony algorithm in Python, the corresponding LocBS-BeeCol software model was compiled, the input data of which are as follows: marshalling yard parameters (area, number of clients to be connected to base stations); WLAN parameters (base station coverage radius; number of clients served by the base station); the bee colony algorithm parameters (number of bees, number of attempts to find the optimal solution by the bee). For example, to connect 300 clients to a medium-capacity marshalling yard with an area of 2 500x500 m<sup>2</sup>, 93 base stations with a coverage radius of 50 m are required.

4. The quality of the obtained solutions largely depends on the choice of the bee colony algorithm parameters. A study of the number of WLAN base stations (solution search time by the bees) on the different number of bees (attempts to find the optimal solution by bees) for marshalling yards of different capacity. It is determined that increase in

## ІНФОРМАЦІЙНО-КОМУНІКАЦІЙНІ ТЕХНОЛОГІЇ ТА МАТЕМАТИЧНЕ МОДЕЛЮВАННЯ

the number of bees and the number of attempts to find the optimal solution by the bee leads to an increase in the quality of the optimal solution – decrease in the number of base stations. In addition, increase in the number of bees leads to a decrease in the time to find the optimal solution and increase in the number of attempts will lead to an increase in the time to find the optimal solution by bees.

5. For a high-capacity marshalling yard in the case of increasing the coverage radius of the WLAN base station twice the number of BS is reduced by about two times, while the time to find the optimal solution for bees increases 2.5 times.

## LIST OF REFERENCE LINKS

1. Скаков Е. С., Малыш В. Н. Пчелиный алгоритм оптимизации для решения задачи планирования беспроводной сети. *Программные продукты и системы*. 2016. № 4 (67). С. 67–73. DOI: <https://doi.org/10.15827/0236-235X.115.067-073>
2. Смирнова О. С., Богорадникова А. В., Блинов М. Ю. Описание роевых алгоритмов, инспирированных неживой природой и бактериями, для использования в онтологической. *International Journal of Open Information Technologies*. 2015. Vol. 3, No. 12. С. 28–37.
3. Ahamed A., Islam N., Soikot M. A. S., Hossen M. S., Ahmed R., Hasan M. A. Train Collision Avoidance Using GPS and GSM Module. *2019 International Conference on Power Electronics, Control and Automation (ICPECA)*. 2019. P. 1–4. DOI: <https://doi.org/10.1109/icpeca47973.2019.8975543>
4. Ai B., Guan K., Rupp M., Kurner T., Cheng X., Yin X.-F., ... Ding J.-W. Future railway services-oriented mobile communications network. *IEEE Communications Magazine*. 2015. Vol. 53. Iss. 10. P. 78–85. DOI: <https://doi.org/10.1109/MCOM.2015.7295467>
5. A Brief Overview of the Wireless World. URL: <https://www.sciencedirect.com/topics/computer-science/basic-service-set>. (date of access: 13.12.2019).
6. A Necessary GSM-R Mobile Upgrade. URL: <https://www.railengineer.co.uk/2019/03/13/a-necessary-gsm-r-mobile-upgrade>. (date of access: 13.12.2019).
7. Banerjee S., Hempel N., Sharif H. A Survey of Wireless Communication Technologies & Their Performance for High Speed Railways. *Journal of Transportation Technologies*. 2016. Vol. 06. Iss. 01. P. 15–29. DOI: <https://doi.org/10.4236/jtts.2016.61003>
8. Davidovic T., Teodorovic D., Selmic M. Bee Colony Optimization – Part I : The Algorithm Overview : Invited survey. *YJOR*. 2015. Vol. 25. Iss. 1. P. 33–56. DOI: <https://doi.org/10.2298/YJOR131011017D>
9. Hussein W. A., Sahran S., Sheikh Abdullah S. N. H. The variants of the Bees Algorithm (BA) : A survey. *Artificial Intelligence Review*. 2017. Vol. 47. Iss. 1. P. 67–121. DOI: <https://doi.org/10.1007/s10462-016-9476-8>
10. Kumar K., Zindani D., Davim J. P. Bees Algorithm. *Optimizing Engineering Problems through Heuristic Techniques*. 2019. P. 43-50. DOI: <https://doi.org/10.1201/9781351049580-5>
11. Nurmi J., Lohan E.-S., Wymeersch H., Seco-Granados G., Nykänen O. *Multi-Technology Positioning*. Springer International Publishing AG. 2017. 348 p. DOI: <https://doi.org/10.1007/978-3-319-50427-8>
12. Osterhage W. *Wireless Network Security*. Taylor & Francis Group. 2018. P. 14–77. DOI: <https://doi.org/10.1201/9781315106373-3>
13. Pakhomova V. M., Skaballanovich T. I., Bondareva V. S. Intelligent routing in the network of information and telecommunication system of railway transport. *Наука та прогрес транспорту*. 2019. № 2 (80). P. 77–90. DOI: <https://doi.org/10.15802/stp2019/166092>
14. Pakhomova V. M., Tsykalo I. D. Optimal route definition in the network based on the multilayer neural model. *Наука та прогрес транспорту*. 2018. № 6 (78). P. 126–142. DOI: <https://doi.org/10.15802/stp2018/154443>
15. Pakhomova V. M., Mandybura Y. S. Optimal route definition in the railway information network using neural-fuzzy models. *Наука та прогрес транспорту*. 2019. № 5 (83). P. 81–98. DOI: <https://doi.org/10.15802/stp2019/184385>
16. Sneps-Snepp M., Namiot D. Digital Railway and How to Move from GSM-R to LTE-R and 5G. *Convergent Cognitive Information Technologies*. 2018. P. 392–402. DOI: [https://doi.org/10.1007/978-3-030-37436-5\\_34](https://doi.org/10.1007/978-3-030-37436-5_34)
17. Vaishali S. Nature – All Mathematics. URL: <http://thebridge.psgtech.ac.in/index.php/2014/11/12/nature-all-mathematics>. (date of access: 13.12.2019).
18. Ying Tan. Survey of swarm intelligence. *Swarm Intelligence Vol. 1 : Principles, current algorithms and methods*. 2018. P. 1–28. DOI: [https://doi.org/10.1049/pbce119f\\_ch1](https://doi.org/10.1049/pbce119f_ch1)

## ІНФОРМАЦІЙНО-КОМУНІКАЦІЙНІ ТЕХНОЛОГІЇ ТА МАТЕМАТИЧНЕ МОДЕЛЮВАННЯ

19. Zhong Z.-D., Ai B., Zhu G., Wu H., Xiong L., Wang F.-G., ... He R.-S. Key Issues for GSM-R and LTE-R. *Dedicated Mobile Communications for High-speed Railway*. 2018. P. 19–55.  
DOI: [https://doi.org/10.1007/978-3-662-54860-8\\_2](https://doi.org/10.1007/978-3-662-54860-8_2)
20. Zhukovyts'kyi I., Pakhomova V. Research of Token Ring network options in automation system of marshaling yard. *Transport Problems*. 2018. Vol. 13. Iss. 2. P. 149–158.  
DOI: <https://doi.org/10.20858/tp.2018.13.2.14>

В. М. ПАХОМОВА<sup>1\*</sup>, Д. І. НАЗАРОВА<sup>2\*</sup>

<sup>1\*</sup>Каф. «Електронні обчислювальні машини», Дніпровський національний університет залізничного транспорту імені академіка В. Лазаряна, вул. Лазаряна, 2, Дніпро, Україна, 49010, тел. +38 (056) 373 15 89, ел. пошта [viknikpakh@gmail.com](mailto:viknikpakh@gmail.com), ORCID 0000-0002-0022-099X

<sup>2\*</sup>Каф. «Електронні обчислювальні машини», Дніпровський національний університет залізничного транспорту імені академіка В. Лазаряна, вул. Лазаряна, 2, Дніпро, Україна, 49010, тел. +38 (056) 373 15 89, ел. пошта [olkdi@outlook.com](mailto:olkdi@outlook.com), ORCID 0000-0002-7134-9416

## ОРГАНІЗАЦІЯ БЕЗДРОТОВОЇ МЕРЕЖІ НА СОРТУВАЛЬНІЙ СТАНЦІЇ З ВИКОРИСТАННЯМ БДЖОЛИНОГО МЕТОДУ

**Мета.** Сьогодні бездротові мережі широко використовують в якості альтернативи дротовим, що дозволяє підключити декілька пристроїв як між собою в локальну, так і до глобальної мережі Інтернет. Але на сучасному етапі в Україні немає масового використання бездротової мережі на залізничному транспорті, тому доцільно провести дослідження розгортання такої мережі, зокрема на сортувальній станції. **Методика.** На програмній моделі «LocBS–BeeCol», що створена мовою Python за алгоритмом бджолиної колонії, визначено оптимальну кількість базових станцій (БС) бездротової мережі та їх розташування на сортувальній станції, проведено дослідження параметрів алгоритму. Вхідні дані моделі «LocBS–BeeCol»: параметри сортувальної станції (площа, кількість клієнтів, яких потрібно підключити до базових станцій); параметри бездротової мережі (радіус покриття базової станції, максимальна кількість клієнтів для однієї базової станції); параметри алгоритму бджолиної колонії (кількість бджіл-розвідників, кількість спроб знайти оптимальне рішення одною бджолою). **Результати.** Для сортувальних станцій різної потужності (малої, середньої та великої) отримано оптимальну кількість базових станцій бездротової мережі за обмежень на радіус покриття базової станції та кількість клієнтів, що підключені до неї. Так, наприклад, для підключення 300 клієнтів на сортувальній станції середньої потужності, площа якої 2 500x500 м<sup>2</sup>, необхідно 93 базових станцій з радіусом покриття 50 м. **Наукова новизна.** Якість отриманих рішень значною мірою залежить від вибору параметрів алгоритму бджолиної колонії. Проведено дослідження кількості базових станцій бездротової мережі та часу пошуку оптимального рішення за різною кількістю бджіл та кількістю спроб знайти оптимальне рішення бджолою для сортувальних станцій різної потужності. Визначено, що збільшення кількості бджіл (із 10 до 50) та кількості спроб знаходження оптимального рішення бджолою (із 10 до 50) призводить до уточнення оптимального рішення (зменшення числа базових станцій у середньому на 6,5 та 9,3 % відповідно). Крім того, збільшення кількості бджіл (із 10 до 50) призводить до зменшення часу пошуку оптимального рішення бджолами в середньому в 1,8 раза, у той час як збільшення кількості спроб знаходження оптимального рішення бджолою (із 10 до 50) призведе до зростання часу пошуку оптимального рішення в середньому в 2,14 раза. **Практична значимість.** Розроблено алгоритм та його програмну реалізацію, які дозволяють визначити необхідну кількість базових станцій та їх розміщення під час розгортання бездротової мережі на сортувальній станції. Для сортувальної станції великої потужності в разі збільшення радіуса покриття базової станції удвічі (із 50 до 100 м) кількість БС зменшується приблизно в два рази (зі 136 до 64), при цьому час пошуку оптимального рішення бджолами збільшується в 2,5 раза (із 8,4 до 20,6 с).

**Ключові слова:** сортувальна станція; бездротова мережа; базова станція (БС); радіус покриття; бджолиний метод; бджоли; спроби; час пошуку

В. Н. ПАХОМОВА<sup>1\*</sup>, Д. И. НАЗАРОВА<sup>2\*</sup>

<sup>1\*</sup>Каф. «Електронні вычислительные машины», Дніпровський національний університет залізничного транспорту імені академіка В. Лазаряна, ул. Лазаряна, 2, Дніпро, Україна, 49010, тел. +38 (056) 373 15 89, ел. пошта viknikpakh@gmail.com, ORCID 0000-0002-0022-099X

<sup>2\*</sup>Каф. «Електронні вычислительные машины», Дніпровський національний університет залізничного транспорту імені академіка В. Лазаряна, ул. Лазаряна, 2, Дніпро, Україна, 49010, тел. +38 (056) 373 15 89, ел. пошта olkdi@outlook.com, ORCID 0000-0002-7134-9416

## ОРГАНИЗАЦИЯ БЕСПРОВОДНОЙ СЕТИ НА СОРТИРОВОЧНОЙ СТАНЦИИ С ИСПОЛЬЗОВАНИЕМ ПЧЕЛИНОГО МЕТОДА

**Цель.** Сегодня беспроводные сети широко используют в качестве альтернативы проводным, что позволяет подключить несколько устройств как между собой в локальную, так и к глобальной сети Интернет. Однако на современном этапе в Украине нет массового использования беспроводной сети на железнодорожном транспорте, поэтому целесообразно провести исследование развертывания такой сети, в частности, на сортировочной станции. **Методика.** На программной модели «LocBS–BeeCol», написанной на языке Python по алгоритму пчелиной колонии, определено оптимальное количество базовых станций (БС) беспроводной сети и их расположение на сортировочной станции, проведено исследование параметров алгоритма. Входные данные модели «LocBS–BeeCol»: параметры сортировочной станции (площадь, количество клиентов, которые нужно подключить к базовым станциям); параметры беспроводной сети (радиус покрытия базовой станции, максимальное количество клиентов для одной базовой станции); параметры алгоритма пчелиной колонии (количество пчел-разведчиков, количество попыток найти оптимальное решение одной пчелой). **Результаты.** Для сортировочных станций различной мощности (малой, средней и высокой) получено оптимальное количество базовых станций беспроводной сети при ограничениях на радиус покрытия базовой станции и количество клиентов, подключенных к ней. Так, например, для подключения 300 клиентов на сортировочной станции средней мощности, площадь которой 2 500x500 м<sup>2</sup>, необходимо 93 базовых станций с радиусом покрытия 50 м. **Научная новизна.** Качество полученных решений в значительной мере зависит от выбора параметров алгоритма пчелиной колонии. Проведено исследование количества базовых станций беспроводной сети и времени поиска оптимального решения при различном числе пчел и количестве попыток найти оптимальное решение пчелой для сортировочных станций различной мощности. Определено, что увеличение количества пчел (с 10 до 50) и количества попыток нахождения оптимального решения пчелой (с 10 до 50) приводит к уточнению оптимального решения (уменьшению числа базовых станций в среднем на 6,5 и 9,3 % соответственно). Кроме этого, увеличение количества пчел (с 10 до 50) приводит к уменьшению времени поиска оптимального решения пчелами в среднем в 1,8 раза, в то время как увеличение количества попыток нахождения оптимального решения пчелой (с 10 до 50) приведет к росту времени поиска оптимального решения в среднем в 2,14 раза. **Практическая значимость.** Разработан алгоритм и его программная реализация, позволяющие определить необходимое количество базовых станций и их размещение при развертывании беспроводной сети на сортировочной станции. Для сортировочной станции высокой мощности при увеличении радиуса покрытия базовой станции вдвое (с 50 до 100 м) количество БС уменьшается примерно в два раза (со 136 до 64), при этом время поиска оптимального решения пчелами увеличивается в 2,5 раза (с 8,4 до 20,6 с).

**Ключевые слова:** сортировочная станция; беспроводная сеть; базовая станция (БС); радиус покрытия; пчелиный метод; пчелы; попытки; время поиска

### REFERENCES

1. Skakov, E., & Malysh, V. (2016). Bee optimization algorithm for solving wireless network planning problem. *Software products and systems*, 4(67), 67-73. DOI: <https://doi.org/10.15827/0236-235X.115.067-073> (in Russian)
2. Smirnova, O., Bogoradnikova, A. & Blinov, M. (2015). Description of swarm algorithms inspired by inanimate nature and bacteria for use in the ontological model. *International Journal of Open Information Technologies*, 3(12), 28-37. (in Russian)

## ІНФОРМАЦІЙНО-КОМУНІКАЦІЙНІ ТЕХНОЛОГІЇ ТА МАТЕМАТИЧНЕ МОДЕЛЮВАННЯ

3. Ahamed, A., Islam, N., Soikot, M. A. S., Hossen, M. S., Ahmed, R., & Hasan, M. A. (2019). Train Collision Avoidance Using GPS and GSM Module. *2019 International Conference on Power Electronics, Control and Automation (ICPECA)*, 1-4. DOI: <https://doi.org/10.1109/icpeca47973.2019.8975543> (in English)
4. Ai, B., Guan, K., Rupp, M., Kurner, T., Cheng, X., Yin, X.-F., ... & Ding, J.-W. (2015). Future railway services-oriented mobile communications network. *IEEE Communications Magazine*, 53(10), 78-85. DOI: <https://doi.org/10.1109/MCOM.2015.7295467> (in English)
5. A Brief Overview of the Wireless World. Retrieved from <https://www.sciencedirect.com/topics/computer-science/basic-service-set>
6. A Necessary GSM-R Mobile Upgrade. Retrieved from <https://www.railengineer.co.uk/2019/03/13/a-necessary-gsm-r-mobile-upgrade>
7. Banerjee, S., Hempel, M., & Sharif, H. (2016). A Survey of Wireless Communication Technologies & Their Performance for High Speed Railways. *Journal of Transportation Technologies*, 06(01), 15-29. DOI: <https://doi.org/10.4236/jtts.2016.61003> (in English)
8. Davidovic, T., Teodorovic, D. & Selmic, M. (2015). Bee Colony Optimization – Part I: The Algorithm Overview: Invited survey. *Yugoslav Journal of Operations Research*, 25(1), 33-56. DOI: <https://doi.org/10.2298/YJOR131011017D> (in English)
9. Hussein, W. A., Sahran, S., & Sheikh Abdullah, S. N. H. (2017). The variants of the Bees Algorithm (BA): a survey. *Artificial Intelligence Review*, 47(1), 67-121. DOI: <https://doi.org/10.1007/s10462-016-9476-8> (in English)
10. Kumar, K., Zindani, D., & Davim, J. P. (2019). *Bees Algorithm*. Optimizing Engineering Problems through Heuristic Techniques. DOI: <https://doi.org/10.1201/9781351049580-5> (in English)
11. Nurmi, J., Lohan, E.-S., Wymeersch, H., Seco-Granados, G., & Nykänen, O. (2017). *Multi-Technology Positioning*. Springer International Publishing AG. DOI: <https://doi.org/10.1007/978-3-319-50427-8> (in English)
12. Osterhage, W. (2018). *Wireless Network Security*. Taylor & Francis Group, 14-77. DOI: <https://doi.org/10.1201/978135106373-3> (in English)
13. Pakhomova, V. M., Skaballanovich, T. I., & Bondareva, V. S. (2019). Intelligent routing in the network of information and telecommunication system of railway transport. *Science and Transport Progress*, 2(80), 77-90. DOI: <https://doi.org/10.15802/stp2019/166092> (in English)
14. Pakhomova, V. M., & Tsykalo, I. D. (2018). Optimal route definition in the network based on the multilayer neural model. *Science and Transport Progress*, 6(78), 126-142. DOI: <https://doi.org/10.15802/stp2018/154443> (in English)
15. Pakhomova, V. M., & Mandybura, Y. S. (2019). Optimal route definition in the railway information network using neural-fuzzy models. *Science and Transport Progress*, 5(83), 81-98. DOI: <https://doi.org/10.15802/stp2019/184385> (in English)
16. Sneps-Sneppe, M., & Namiot, D. (2020). *Digital Railway and How to Move from GSM-R to LTE-R and 5G*. Convergent Cognitive Information Technologies, 392-402. DOI: [https://doi.org/10.1007/978-3-030-37436-5\\_34](https://doi.org/10.1007/978-3-030-37436-5_34) (in English)
17. Vaishali, S. Nature-All-Mathematics. Retrieved from <http://thebridge.psgtech.ac.in/index.php/2014/11/12/nature-all-mathematics>
18. Ying, Tan. (2018). Survey of swarm intelligence. *Swarm Intelligence-Vol. 1: Principles, current algorithms and methods*, 1-28. DOI: [https://doi.org/10.1049/pbce119f\\_ch1](https://doi.org/10.1049/pbce119f_ch1) (in English)
19. Zhong, Z.-D., Ai, B., Zhu, G., Wu, H., Xiong, L., Wang, F.-G., ... & He, R.-S. (2017). *Key Issues for GSM-R and LTE-R*. Dedicated Mobile Communications for High-Speed Railway, 19-55. DOI: [https://doi.org/10.1007/978-3-662-54860-8\\_2](https://doi.org/10.1007/978-3-662-54860-8_2) (in English)
20. Zhukovyts'kyi, I., & Pakhomova, V. (2018). Research of Token Ring network options in automation system of marshalling yard. *Transport Problems*, 13(2), 149-158. DOI: <https://doi.org/10.20858/tp.2018.13.2.1> (in English)

Received: November 19, 2019

Accepted: March 17, 2020